

# 292/560

## Dimensions

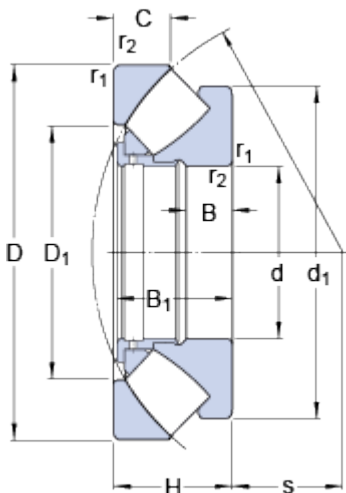

d	560	mm
D	750	mm
H	115	mm
d <sub>1</sub>	≈ 732	mm
D <sub>1</sub>	≈ 644	mm
B	37	mm
B <sub>1</sub>	111	mm
C	61	mm
s	302	mm
r <sub>1,2</sub>	min. 5	mm

## Abutment dimensions

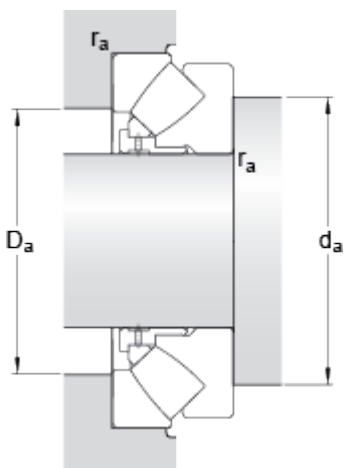

d <sub>a</sub>	min. 655	mm
D <sub>a</sub>	max. 685	mm
r <sub>a</sub>	max. 4	mm

## Calculation data

Basic dynamic load rating	C	2990	kN
Basic static load rating	C <sub>0</sub>	16000	kN
Fatigue load limit	P <sub>u</sub>	1220	kN
Reference speed		480	r/min
Limiting speed		800	r/min
Minimum axial load factor	A	24	

## Mass

Mass bearing		140	kg
--------------	--	-----	----